

# SONIA

Hear clearly, wherever you are.

VERSION 1





# BRING EVERYONE INTO THE DISCUSSION

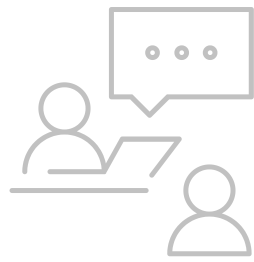

## The Problem

In larger collaboration spaces such as conference rooms and classrooms, soundbars and speakers near the display won't adequately cover the space. Room users closer to the display will endure an unpleasant volume level while those at the back may not hear at all.

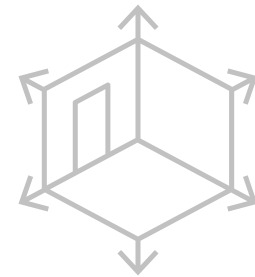

## The Solution

Distributed speakers, such as the Sonia Series, enable you to locate speakers evenly across the space to cover a smaller area with each device — making overall volume lower, more comfortable, and removing echos and booms. Now, those at the front and back of the room can hear the same — with comfort.



# SONIA GIVES EVERYONE THE ABILITY TO DEPLOY GREAT AUDIO.

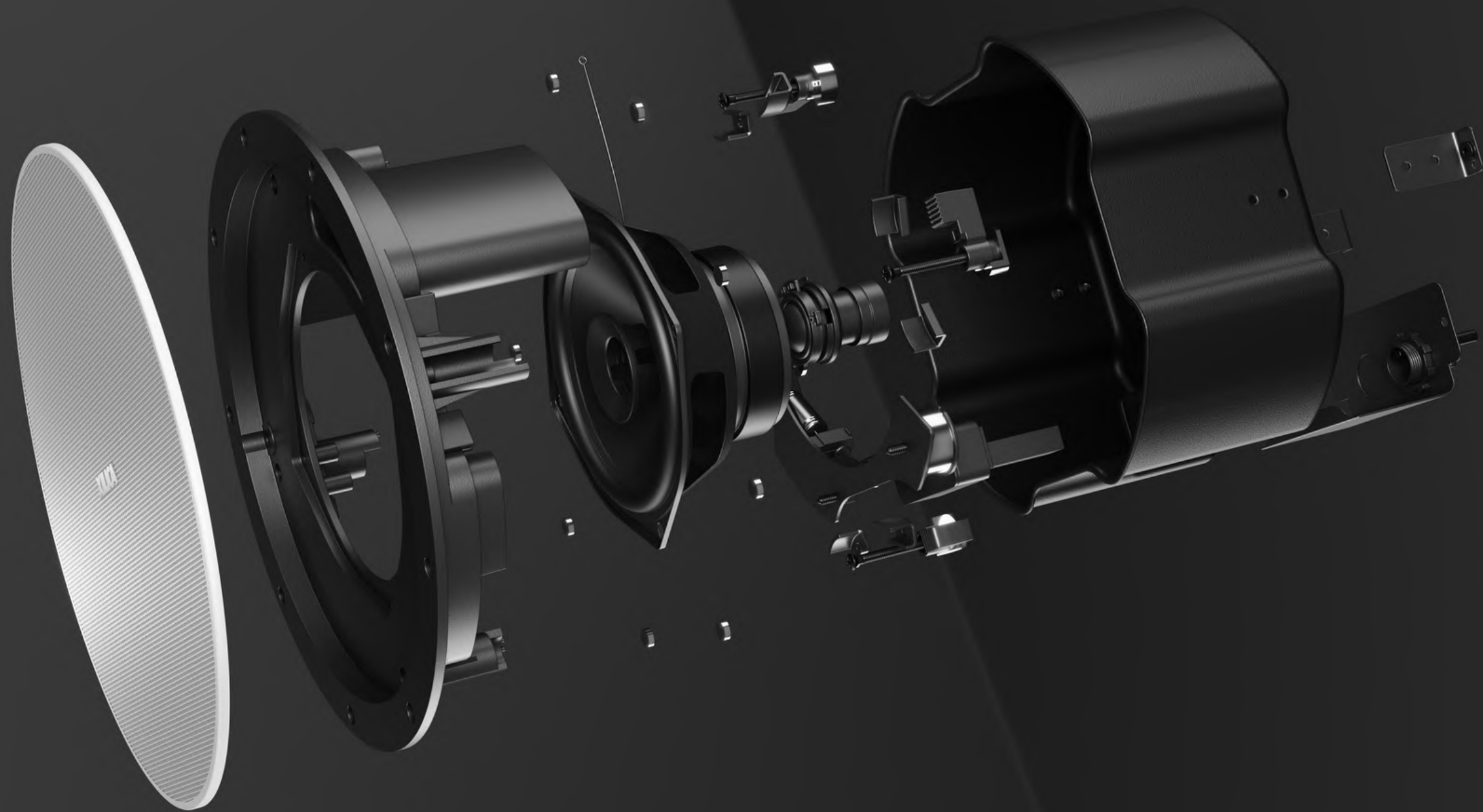

Unlike traditional speaker systems, Sonia is based on Category cable – enabling everyone, with any level of audio knowledge, to deploy great sound in their space. Sonia systems are truly plug-and-play: with no proprietary connectors, wiring diagrams, messy termination or expensive copper cable. Whether you're an AV integrator, IT technician or technology manager, Sonia makes installing speakers easy.





## KEEP YOUR ROOM CLEAR.

Sonia Amp mounts directly onto Sonia C5 for invisible, in-ceiling installation. Plenum rated, the entire configuration eliminates in-room amplifier racks and hefty, expensive copper cable — and, Sonia C5 includes double-stepped, long travel mount ears for blind installation from below the ceiling.



## SIMPLY CONNECTED.

Sonia Amp is designed for the modern collaboration space and includes a built-in network switch, enabling you to power an external ceiling microphone array direct from the device. That's just one CatX drop to the ceiling for your entire AV system.

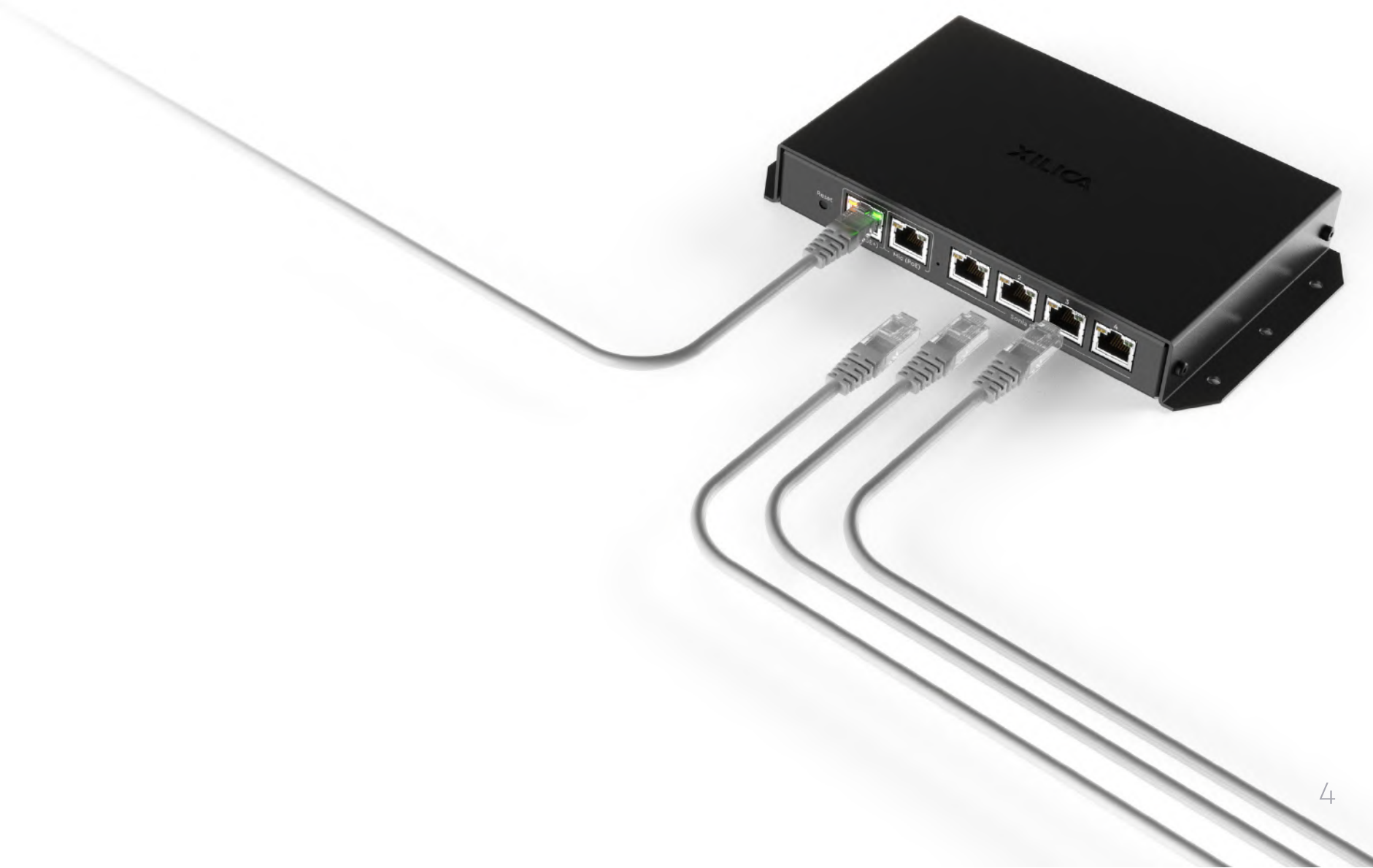

# DON'T WORRY ABOUT COMPATIBILITY.

Sonia Amp and Sonia C5 were designed to work together with just a click – say goodbye to calculations about power handling, resistance and time-consuming speaker tuning. Pre-built templates for Sonia systems are available in Xilica Designer — so room deployment really can be turn-key.

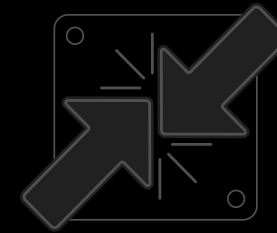

# SONIA C5 – EXCEPTIONAL AUDIO QUALITY.

Sonia C5 incorporates a soft, silk-domed tweeter for smooth tonality and a 5.25" low-frequency transducer to give the ideal size-to-sound ratio for modern meeting spaces. Sonia C5's wide, even dispersion pattern enables fewer speakers in large spaces.

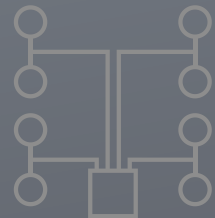
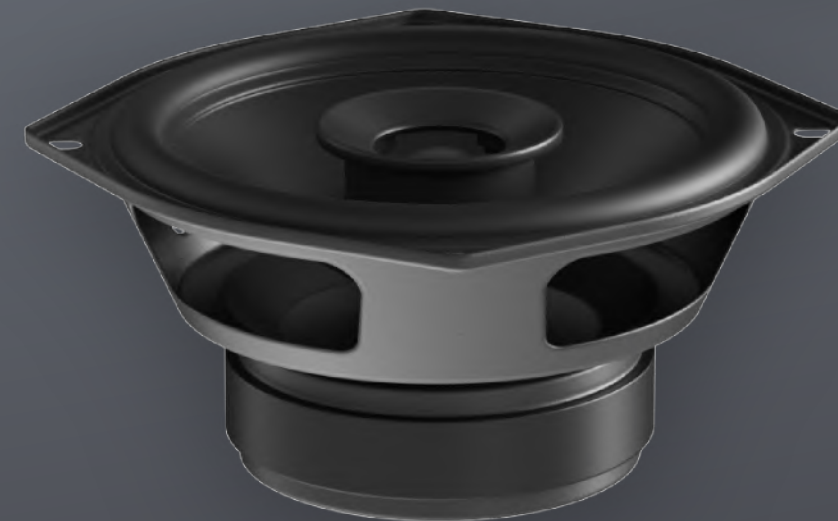

Power up to eight Sonia C5 speakers from a single Sonia Amp, linking them in pairs for greater coverage with less cable.



Sonia is optimized for highly-intelligible speech with VoiceMatch™ in each Xilica processor.



StudioX™-designed grille that is magnetically attached without tools, and paintable in any color with removable logo.



# SONIA AMP – CENTRALIZED CONTROL.



Running like a standard IT appliance, Sonia Amp enables centralized monitoring, management and control without the cost of individually-addressable speakers.

With fault sensing between Sonia C5 speakers and the Sonia Amp, and dedicated VoiceMatch™ settings in each Xilica processor, end-users benefit from the same core functionality as an IP speaker without the expense.

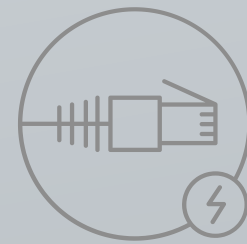

Single CatX for power and data, with Sonia Amp supporting Dante™ and PoE+.

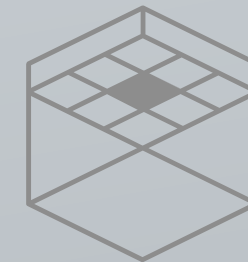

Plenum rated, enabling invisible installation in drop ceilings and air-handling spaces with mounting directly onto Sonia C5.

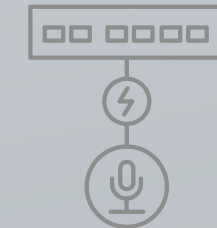

Integrated network switch with PoE, connecting external ceiling microphones with just one cable.

# ROOM FLEXIBILITY

MEDIUM MEETING ROOM

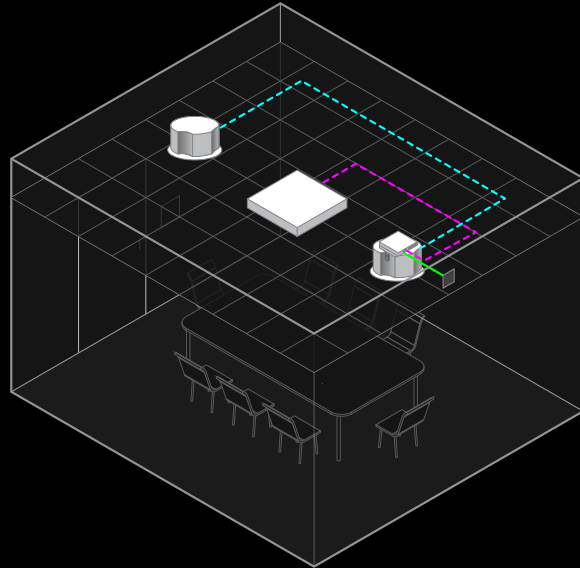

HIGHER EDUCATION CLASSROOM

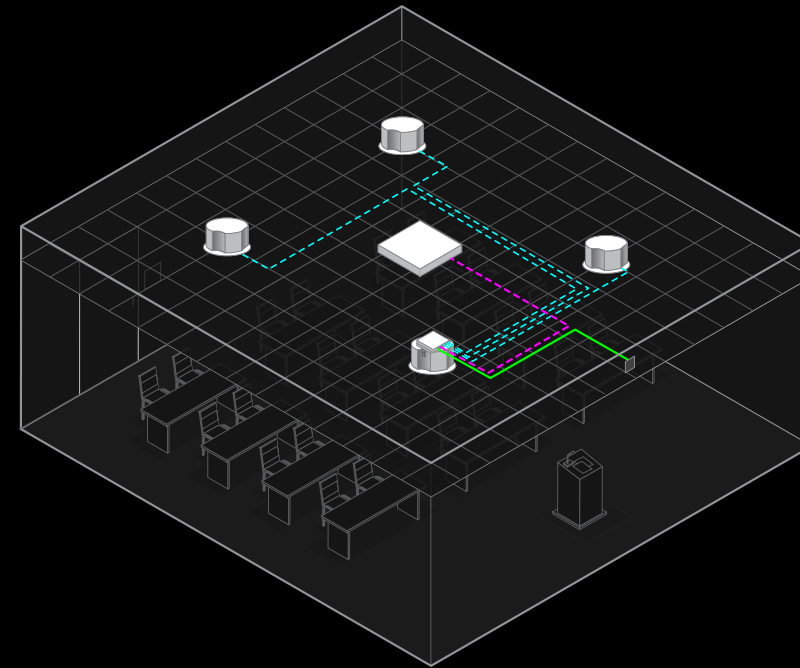

MULTIPLE MEETING ROOMS

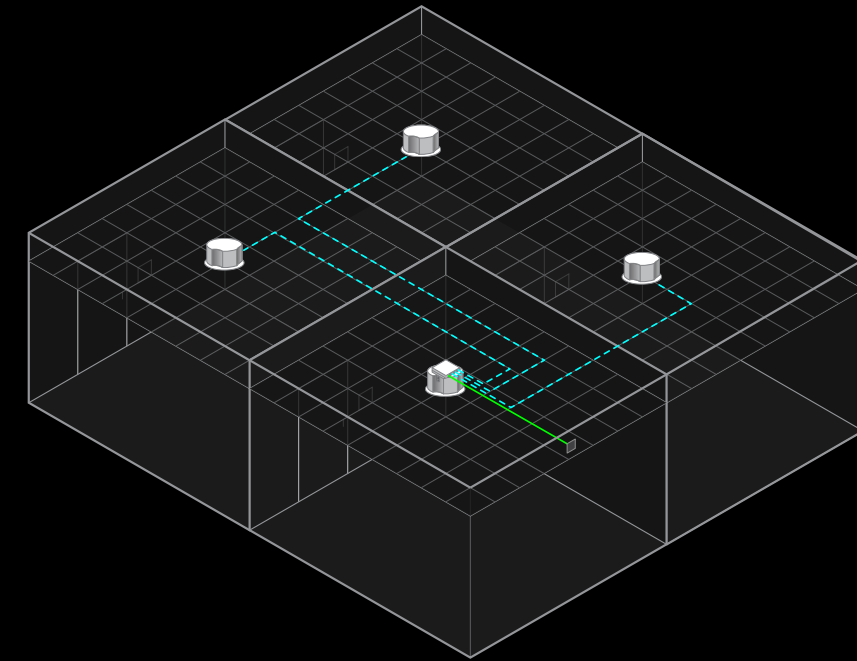

- CATX FROM IDF CLOSET, DANTE/POE+
- CATX TO SONIA C5, POWERED AUDIO OVER ETHERNET
- CATX TO/FROM MICROPHONE, DANTE/POE



**LEARN MORE AT [XILICA.COM/SONIA](https://xilica.com/sonia)**  
DRIVING AUTHENTIC INTERACTION